

SIEMENS

Desigo CC

Life Science Common Library

Laboratory solutions & monitoring static symbols

Key Words: Life Science, symbols, libraries, Desigo CC, laboratory solutions, monitoring, CMT

Document Type: **Technical Manual**
Revision Date: **07.09.2017**
EM Version: **3.0.0111.0**

Author: **Spas Ormandzhiev**
Company: **Siemens**

Table of Contents

1. About this document	4
1.1. Purpose	4
1.2. Scope	4
2. Library version	4
3. Life Science Common library (BA_Room_Laboratory_101_HQ_1).....	5
3.1. Symbols.....	5
3.1.1. DYN_2D_Gauge_Angular_Generic_Central_001_101	5
3.1.2. DYN_2D_Gauge_Angular_Generic_Central_002_101	7
3.1.3. DYN_2D_Gauge_Column_Generic_Central_001_101	9
3.1.4. DYN_2D_Gauge_Column_Generic_Central_002_101	11
3.1.5. DYN_2D_Gauge_Square_Generic_Central_001_101	14
3.1.6. DYN_2D_Gauge_Square_Generic_Central_002_101	15
3.1.7. STA_2D_Inlet_Air_None_Vertical_001_101	17
3.1.8. STA_2D_Lab_Fume Hood_Analog_Central_001_101.....	18
3.1.9. STA_2D_Lab_Fume Hood_Analog_Central_002_101.....	19
3.1.10. STA_2D_Lab_Fume Hood_Dual Entry_Central_001_101.....	20
3.1.11. STA_2D_Lab_Fume Hood_Walk In_Central_001_101.....	21
3.1.12. STA_2D_Lab_Fume Hood_Multi Walk In_Central_001_101	22
3.1.13. STA_2D_Lab_Canopy_None_Central_001_101	23
3.1.14. STA_2D_Lab_Canopy_Workbench_Central_001_101.....	24
3.1.15. STA_2D_Lab_Workbench_None_Central_001_101	25
3.1.16. STA_2D_Lab_Snorkel Hood_Central_001_101	26
3.1.17. STA_2D_Damper_Air_Volume Regulator_All_001_101.....	27
3.1.18. STA_2D_Lab_Damper_Venturi_Central_001_101	28
3.1.19. STA_2D_Outlet_Air_None_Vertical_001_101	29
3.1.20. STA_2D_Panel Door_None_None_None_001_101	30
3.1.21. STA_2D_Panel Door_None_None_None_002_101.....	31
3.1.22. STA_2D_Room Sensor_Particles_None_All_002_101.....	32
3.1.23. STA_2D_Room Sensor_Particles_None_All_003	33
3.1.24. STA_2D_Sensor_Particles_None_All_001_101.....	34
3.1.25. STA_2D_Sensor_Particles_None_All_002_101.....	35
3.1.26. STA_2D_Sensor_Particles_None_All_003.....	36
3.1.27. STA_2D_Sensor_Particles_None_All_003.....	37
3.1.28. STA_3D_Lab_Canopy_Workbench_Central_001_101.....	38
3.1.29. STA_3D_Lab_Workbench_None_Central_001_101	39

3.1.30.	STA_3D_Lab_Fume Hood_None_Central_001_101	40
3.1.31.	STA_3D_Lab_Fume Hood_None_Central_002_101	41
3.1.32.	STA_3D_Lab_Fume Hood_Dual Entry_Central_001_101	42
3.1.33.	STA_3D_Lab_Fume Hood_Walk In_Central_001_101	43
3.1.34.	STA_3D_Lab_Fume Hood_Multi Walk In_Central_001_101	44
3.1.35.	STA_3D_Lab_Snorkel Hood_Central_001_101	45
3.2.	Sample graphics	46
3.2.1.	SampleGraphic_LifeScience_Dashboard_001_101	46
3.2.2.	SampleGraphic_LifeScience_Dashboard_002_101	47
3.2.3.	SampleGraphic_LifeScience_Dashboard_002_101	47
3.3.	Icons	48

1. About this document

1.1. Purpose

This document describes the content of the Life Science Common Library delivery for the Management Station. It helps Project Engineers and Graphics Engineers to get a quick overview of the available basic graphic elements, such as static- and dynamic graphic symbols, functions, icons and sample pages. It provides information about the available shapes and data point substitutions for dynamic symbols and templates.

1.2. Scope

This document applies to the Desigo CC MP3.0 and Extension module “Life Science Common”

2. Library version

Description	Name	Version
Life Science Common library	BA_Room_Laboratory_101_HQ_1	1.4

3. Life Science Common library (BA_Room_Laboratory_101_HQ_1)

3.1. Symbols

3.1.1. DYN_2D_Gauge_Angular_Generic_Central_001_101

Symbol Name			
DYN_2D_Gauge_Angular_Generic_Central_001_101			
Library			
BA_Room_Laboratory_101_HQ_1			
Description			
Gauge	Angular	Generic	Gradient color change - green to red
Symbol			
<p>Title</p> 			
Substitutions		Set of Values	
*Datapoint		Dynamic symbol representing generic angular indicator/gauge in the range from Range Minimum to Range Maximum	
Eng Units		User can set the engineering unit. If the field is empty the system will display the data point's engineering unit. (Default value = Unit)	
Eng Units Fonts Size		User can set the engineering unit font size (Default value = 16)	
Gauge Title		User can set the gauge title (Default Text = Title)	
Gauge Title Color		User can set the gauge title color as a color name or the RGB code. Default value: #FF808080	

Gauge Title Font Size	User can set the gauge title font size. (Default value = 16)
Range Maximum	User can set the maximum scale range. (Default value = 100)
Range Minimum	User can set the minimum scale range. (Default value = 0)
Value Font Size	User can set the value font size. (Default value = 36)
Value Precision	0 = No digits after decimal point (Default value) 1 = One digit after decimal point 2 to n = Two to n digits after decimal point

3.1.2. DYN_2D_Gauge_Angular_Generic_Central_002_101

Symbol Name			
DYN_2D_Gauge_Angular_Generic_Central_002_101			
Library			
BA_Room_Laboratory_101_HQ_1			
Description			
Gauge	Angular	Generic	Discrete color change – 3 colors
Symbol			
<p>Title</p> 			
Substitutions		Set of Values	
*Datapoint		Dynamic symbol representing generic angular indicator/gauge in the range from Range Minimum to Range Maximum	
Eng Units		User can set the engineering unit. If the field is empty the system will display the data point's engineering unit. (Default value = Unit)	
Eng Units Fonts Size		User can set the engineering unit font size (Default value = 16)	
Gauge Title		User can set the gauge title (Default Text = Title)	
Gauge Title Color		User can set the gauge title color as a color name or the RGB code. Default value: #FF808080	
Gauge Title Font Size		User can set the gauge title font size. (Default value = 16)	

Range 1 Color	User can set the gauge color in the range *Datapoint < Range 1 Limit User can type in the color name or the RGB code. Default value: #FF00FF00 (Light Green)
Range 1 Limit	User can set the upper limit for Range 1 (Default value = 33)
Range 2 Color	User can set the gauge color in the range Range 1 Limit < *Datapoint < Range 2 Limit User can type in the color name or the RGB code. Default value: #FFFFFF00 (Yellow)
Range 2 Limit	User can set the upper limit for Range 2 (Default value = 66)
Range 3 Color	User can set the gauge color in the range Range 2 Limit < *Datapoint User can type in the color name or the RGB code. Default value: #FFFF0000 (Red)
Range Maximum	User can set the maximum scale range. (Default value = 100)
Range Minimum	User can set the minimum scale range. (Default value = 0)
Value Font Size	User can set the value font size. (Default value = 36)
Value Precision	0 = No digits after decimal point (Default value) 1 = One digit after decimal point 2 to n = Two to n digits after decimal point

3.1.3. DYN_2D_Gauge_Column_Generic_Central_001_101

Symbol Name			
DYN_2D_Gauge_Column_Generic_Central_001_101			
Library			
BA_Room_Laboratory_101_HQ_1			
Description			
Gauge	Column	Generic	Gradient color change - green to red
Symbol			
			
Substitutions		Set of Values	
*Datapoint		Dynamic symbol representing generic vertical bar indicator/gauge in the range from Range Minimum to Range Maximum	
Eng Units		User can set the engineering unit. If the field is empty the system will display the data point's engineering unit. (Default value = Unit)	
Eng Units Fonts Size		User can set the engineering unit font size (Default value = 14)	
Gauge Title		User can set the gauge title (Default Text = Title)	

Gauge Title Color	User can set the gauge title color as a color name or the RGB code. Default value: #FF808080
Gauge Title Font Size	User can set the gauge title font size. (Default value = 14)
Range Maximum	User can set the maximum scale range. (Default value = 100)
Range Minimum	User can set the minimum scale range. (Default value = 0)
Value Font Size	User can set the value font size. (Default value = 36)
Value Precision	0 = No digits after decimal point 1 = One digit after decimal point (Default value) 2 to n = Two to n digits after decimal point
Visible Background	User can choose if a semitransparent dark gray background to be visible or not. 0 = Not visible 1 = Visible (Default value)

3.1.4. DYN_2D_Gauge_Column_Generic_Central_002_101

Symbol Name			
DYN_2D_Gauge_Column_Generic_Central_002_101			
Library			
BA_Room_Laboratory_101_HQ_1			
Description			
Gauge	Column	Generic	Discrete color change – 3 colors
Symbol			
			
Substitutions		Set of Values	
*Datapoint		Dynamic symbol representing generic vertical bar indicator/gauge in the range from Range Minimum to Range Maximum	
Eng Units		User can set the engineering unit. If the field is empty the system will display the data point's engineering unit. (Default value = Unit)	
Eng Units Fonts Size		User can set the engineering unit font size (Default value = 14)	
Gauge Title		User can set the gauge title (Default Text = Title)	

Gauge Title Color	User can set the gauge title color as a color name or the RGB code. Default value: #FF808080
Gauge Title Font Size	User can set the gauge title font size. (Default value = 14)
Range 1 Color	User can set the gauge color in the range *Datapoint < Range 1 Limit User can type in the color name or the RGB code. Default value: #FF00FF00 (Light Green)
Range 1 Limit	User can set the upper limit for Range 1 (Default value = 33)
Range 1 Value Color	User can set the value color in the range *Datapoint < Range 1 Limit User can type in the color name or the RGB code. Default value: #FF808080
Range 2 Color	User can set the gauge color in the range Range 1 Limit < *Datapoint < Range 2 Limit User can type in the color name or the RGB code. Default value: #FFFFFF00 (Yellow)
Range 2 Limit	User can set the upper limit for Range 2 (Default value = 66)
Range 2 Value Color	User can set the value color in the range Range 1 Limit < *Datapoint < Range 2 Limit User can type in the color name or the RGB code. Default value: #FF808080
Range 3 Color	User can set the gauge color in the range Range 2 Limit < *Datapoint User can type in the color name or the RGB code. Default value: #FFFF0000 (Red)
Range 3 Value Color	User can set the value color in the range Range 2 Limit < *Datapoint User can type in the color name or the RGB code. Default value: #FFFFFFFF (White)
Range Maximum	User can set the maximum scale range.

	(Default value = 100)
Range Minimum	User can set the minimum scale range. (Default value = 0)
Value Font Size	User can set the value font size. (Default value = 14)
Value Precision	0 = No digits after decimal point 1 = One digit after decimal point (Default value) 2 to n = Two to n digits after decimal point
Visible Background	User can choose if a semitransparent dark gray background to be visible or not. 0 = Not visible 1 = Visible (Default value)

3.1.5. DYN_2D_Gauge_Square_Generic_Central_001_101

Symbol Name			
DYN_2D_Gauge_Square_Generic_Central_001_101			
Library			
BA_Room_Laboratory_101_HQ_1			
Description			
Gauge	Square	Generic	Gradient color change - green to red
Symbol			
			
Substitutions		Set of Values	
*Datapoint		Dynamic symbol representing generic indicator/gauge in the range from Range Minimum to Range Maximum	
Eng Units		User can set the engineering unit. If the field is empty the system will display the data point's engineering unit. (Default value = <i>empty</i>)	
Gauge Title		User can set the gauge title (Default Text = Title)	
Gauge Title Font Size		User can set the gauge title font size. (Default value = 14)	
Range Maximum		User can set the maximum scale range. (Default value = 100)	
Range Minimum		User can set the minimum scale range. (Default value = 0)	
Value Font Size		User can set the value font size. (Default value = 24)	
Value Precision		0 = No digits after decimal point 1 = One digit after decimal point (Default value) 2 to n = Two to n digits after decimal point	

3.1.6. DYN_2D_Gauge_Square_Generic_Central_002_101

Symbol Name			
DYN_2D_Gauge_Square_Generic_Central_002_101			
Library			
BA_Room_Laboratory_101_HQ_1			
Description			
Gauge	Square	Generic	Discrete color change – 3 colors
Symbol			
			
Substitutions		Set of Values	
*Datapoint		Dynamic symbol representing generic indicator/gauge in the range from Range Minimum to Range Maximum	
Eng Units		User can set the engineering unit. If the field is empty the system will display the data point's engineering unit. (Default value = <i>empty</i>)	
Gauge Title		User can set the gauge title (Default Text = Title)	
Range 1 Color		User can set the gauge color in the range *Datapoint < Range 1 Limit User can type in the color name or the RGB code. Default value: #FF00FF00 (Light Green)	
Range 1 Limit		User can set the upper limit for Range 1 (Default value = 33)	
Range 1 Text Color		User can set the texts color in the range *Datapoint < Range 1 Limit User can type in the color name or the RGB code. Default value: #FF808080	

Range 2 Color	User can set the gauge color in the range Range 1 Limit < *Datapoint < Range 2 Limit User can type in the color name or the RGB code. Default value: #FFFFFF00 (Yellow)
Range 2 Limit	User can set the upper limit for Range 2 (Default value = 66)
Range 2 Text Color	User can set the value color in the range Range 1 Limit < *Datapoint < Range 2 Limit User can type in the color name or the RGB code. Default value: #FF808080
Range 3 Color	User can set the gauge color in the range Range 2 Limit < *Datapoint User can type in the color name or the RGB code. Default value: #FFFF0000 (Red)
Range 3 Text Color	User can set the value color in the range Range 2 Limit < *Datapoint User can type in the color name or the RGB code. Default value: #FFFFFFFF (White)
Value Font Size	User can set the value font size. (Default value = 24)
Value Precision	0 = No digits after decimal point 1 = One digit after decimal point (Default value) 2 to n = Two to n digits after decimal point

3.1.7. STA_2D_Inlet_Air_None_Vertical_001_101

Symbol Name			
STA_2D_Inlet_Air_None_Vertical_001_101			
Library			
BA_Room_Laboratory_101_HQ_1			
Description			
Inlet	Air	Vertical	Vertical
Symbol			
			

3.1.8. STA_2D_Lab_Fume Hood_Analog_Central_001_101

Symbol Name			
STA_2D_Lab_Fume Hood_Analog_Central_001_101			
Library			
BA_Room_Laboratory_101_HQ_1			
Description			
Lab	Fume Hood	Analog	Central
Symbol			
			
Substitutions		Set of Values	
*		Static symbol representing fume hood. Sash changing position from 0 (closed) to 100% (open)	
Color		User can set the fume hood color. Default value: #FFF2F2F2	
Grill Visibility		0 = Grill is not visible 1 = Grill is visible (Default value)	
ODP Position		0 = Left 1 = Right (Default value)	

3.1.9. STA_2D_Lab_Fume Hood_Analog_Central_002_101

Symbol Name			
STA_2D_Lab_Fume Hood_Analog_Central_002_101			
Library			
BA_Room_Laboratory_101_HQ_1			
Description			
Lab	Fume Hood	Analog	Central
Symbol			
			
Substitutions		Set of Values	
*		Static symbol representing fume hood. Sash changing position from 0 (closed) to 100% (open)	
Color		User can set the fume hood color. Default value: #FFF2F2F2	
Grill Visibility		0 = Grill is not visible 1 = Grill is visible (Default value)	
ODP Position		0 = Left 1 = Right (Default value)	

3.1.10. STA_2D_Lab_Fume Hood_Dual Entry_Central_001_101

Symbol Name			
STA_2D_Lab_Fume Hood_Dual Entry_Central_001_101			
Library			
BA_Room_Laboratory_101_HQ_1			
Description			
Lab	Fume Hood	Dual Entry	Central
Symbol			
			
Substitutions		Set of Values	
*		Static symbol representing fume hood with dual entry. Sash changing position from 0 (closed) to 100% (open)	
Color		User can set the fume hood color. Default value: #FFF2F2F2	
Grill Visibility		0 = Grill is not visible 1 = Grill is visible (Default value)	
ODP Position		0 = Left 1 = Right (Default value)	

3.1.11. STA_2D_Lab_Fume Hood_Walk In_Central_001_101

Symbol Name			
STA_2D_Lab_Fume Hood_Walk In_Central_001_101			
Library			
BA_Room_Laboratory_101_HQ_1			
Description			
Lab	Fume Hood	Walk In	Central
Symbol			
			
Substitutions		Set of Values	
*		Static symbol representing fume hood. Sash changing position from 0 (closed) to 100% (open)	
Color		User can set the fume hood color. Default value: #FFF2F2F2	
Grill Visibility		0 = Grill is not visible 1 = Grill is visible (Default value)	
ODP Position		0 = Left 1 = Right (Default value)	

3.1.12. STA_2D_Lab_Fume Hood_Multi Walk In_Central_001_101

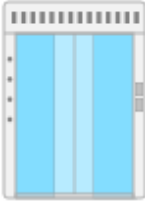
Symbol Name			
STA_2D_Lab_Fume Hood_Multi Walk In_Central_001_101			
Library			
BA_Room_Laboratory_101_HQ_1			
Description			
Lab	Fume Hood	Multi Walk In	Central
Symbol			
			
Substitutions		Set of Values	
*		Static symbol representing fume hood multi walk in. Sash changing position from 0 (closed) to 100% (open)	
Color		User can set the fume hood color. Default value: #FFF2F2F2	
Grill Visibility		0 = Grill is not visible 1 = Grill is visible (Default value)	
ODP Position		0 = Left 1 = Right (Default value)	

3.1.13. STA_2D_Lab_Canopy_None_Central_001_101

Symbol Name			
STA_2D_Lab_Canopy_None_Central_001_101			
Library			
BA_Room_Laboratory_101_HQ_1			
Description			
Lab	Canopy	None	Central
Symbol			
			
Substitutions		Set of Values	
Color		User can set the canopy color. Default value: #FFF2F2F2	

3.1.14. STA_2D_Lab_Canopy_Workbench_Central_001_101

Symbol Name			
STA_2D_Lab_Canopy_Workbench_Central_001_101			
Library			
BA_Room_Laboratory_101_HQ_1			
Description			
Lab	Canopy	Workbench	Central
Symbol			
			
Substitutions		Set of Values	
Color		User can set the canopy and workbench color. Default value: #FFF2F2F2	

3.1.15. STA_2D_Lab_Workbench_None_Central_001_101

Symbol Name			
STA_2D_Lab_Workbench_None_Central_001_101			
Library			
BA_Room_Laboratory_101_HQ_1			
Description			
Lab	Workbench	None	Central
Symbol			
			
Substitutions		Set of Values	
Color		User can set the workbench color. Default value: #FFF2F2F2	

3.1.16. STA_2D_Lab_Snorkel Hood_Central_001_101

Symbol Name			
STA_2D_Lab_Snorkel Hood_Central_001_101			
Library			
BA_Room_Laboratory_101_HQ_1			
Description			
Lab	Snorkel Hood	Central	
Symbol			
			
Substitutions		Set of Values	
Color		User can set the canopy and workbench color. Default value: #FFF2F2F2	

3.1.17. STA_2D_Damper_Air_Volume Regulator_All_001_101

Symbol Name			
STA_2D_Damper_Air_Volume Regulator_All_001_101			
Library			
BA_Room_Laboratory_101_HQ_1			
Description			
Damper	Air	Volume Regulator	All
Symbol			
			
Substitutions		Set of Values	
Direction		0 = Damper without motor actuator 1 = Damper down (Default value) 2 = Damper left 3 = Damper up 4 = Damper right	
Inverse Direction		Possibility to change flow direction. 0=Standard direction (Default value) 1= Inverse direction	

3.1.18. STA_2D_Lab_Damper_Venturi_Central_001_101

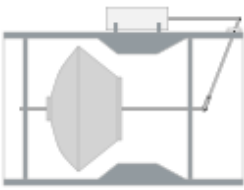
Symbol Name			
STA_2D_Lab_Damper_Venturi_Central_001_101			
Library			
BA_Room_Laboratory_101_HQ_1			
Description			
Lab	Damper	Venturi	Central
Symbol			
			
Substitutions		Set of Values	
*		Static symbol representing venture damper. Damper changing position from 100% (closed) to 0% (open)	

3.1.19. STA_2D_Outlet_Air_None_Vertical_001_101

Symbol Name			
STA_2D_Outlet_Air_None_Vertical_001_101			
Library			
BA_Room_Laboratory_101_HQ_1			
Description			
Outlet	Air	Vertical	
Symbol			
			

3.1.20. STA_2D_Panel Door_None_None_None_001_101

Symbol Name			
STA_2D_Panel Door_None_None_None_001_101			
Library			
BA_Room_Laboratory_101_HQ_1			
Description			
Panel Door	Size 1		
Symbol			
			
Substitutions		Set of Values	
*DoorOpened		Static symbol representing panel door – closed/ opened	

3.1.21. STA_2D_Panel Door_None_None_None_002_101

Symbol Name			
STA_2D_Panel Door_None_None_None_002_101			
Library			
BA_Room_Laboratory_101_HQ_1			
Description			
Panel Door	Size 2		
Symbol			
			
Substitutions		Set of Values	
*DoorOpened		Static symbol representing panel door –closed/ opened	

3.1.22. STA_2D_Room Sensor_Particles_None_All_002_101

Symbol Name			
STA_2D_Room Sensor_Particles_None_All_002_101			
Library			
BA_Room_Laboratory_101_HQ_1			
Description			
Room sensor	Particles	Particles size 0.5µm	
Symbol			
			
Substitutions		Set of Values	

3.1.23. STA_2D_Room Sensor_Particles_None_All_003

Symbol Name			
STA_2D_Room Sensor_Particles_None_All_003			
Library			
BA_Room_Laboratory_101_HQ_1			
Description			
Room sensor	Particles	Particles size 5µm	
Symbol			
			
Substitutions		Set of Values	

3.1.24. STA_2D_Sensor_Particles_None_All_001_101

Symbol Name			
STA_2D_Sensor_Particles_None_All_001_101			
Library			
BA_Room_Laboratory_101_HQ_1			
Description			
Sensor	Particles	All Directions	
Symbol			
			
Substitutions		Set of Values	
Direction		0 = Sensor without probe 1 = Probe up 2 = Probe right 3 = Probe down (Default value) 4 = Probe left	

3.1.25. STA_2D_Sensor_Particles_None_All_002_101

Symbol Name			
STA_2D_Sensor_Particles_None_All_002_101			
Library			
BA_Room_Laboratory_101_HQ_1			
Description			
Sensor	Particles	All Directions	
Symbol			
			
Substitutions		Set of Values	
Direction		0 = Sensor without probe 1 = Probe up 2 = Probe right 3 = Probe down (Default value) 4 = Probe left	

3.1.26. STA_2D_Sensor_Particles_None_All_003_101

Symbol Name			
STA_2D_Sensor_Particles_None_All_003_101			
Library			
BA_Room_Laboratory_101_HQ_1			
Description			
Sensor	Particles	All Directions	
Symbol			
			
Substitutions		Set of Values	
Direction		0 = Sensor without probe 1 = Probe up 2 = Probe right 3 = Probe down (Default value) 4 = Probe left	

3.1.27. STA_3D_Lab_Canopy_None_Central_001_101

Symbol Name			
STA_3D_Lab_Canopy_None_Central_001_101			
Library			
BA_Room_Laboratory_101_HQ_1			
Description			
Lab	Canopy	None	Central
Symbol			
			
Remarks:			
Substitutions		Set of Values	
Color		User can set the canopy color. Default value: #FFF2F2F2	

3.1.28. STA_3D_Lab_Canopy_Workbench_Central_001_101

Symbol Name			
STA_3D_Lab_Canopy_Workbench_Central_001_101			
Library			
BA_Room_Laboratory_101_HQ_1			
Description			
Lab	Canopy	Workbench	Central
Symbol			
			
Remarks:			
Substitutions		Set of Values	
Color		User can set the canopy and workbench color. Default value: #FFF2F2F2	

3.1.29. STA_3D_Lab_Workbench_None_Central_001_101

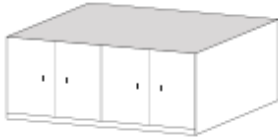
Symbol Name			
STA_3D_Lab_Workbench_None_Central_001_101			
Library			
BA_Room_Laboratory_101_HQ_1			
Description			
Lab	Workbench	None	Central
Symbol			
			
Remarks:			
Substitutions		Set of Values	
Color		User can set the workbench color. Default value: #FFF2F2F2	

3.1.30. STA_3D_Lab_Fume Hood_None_Central_001_101

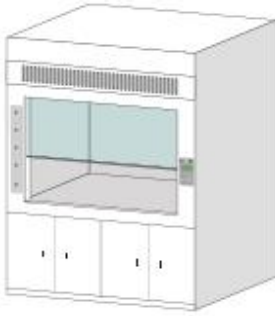
Symbol Name			
STA_3D_Lab_Fume Hood_None_Central_001_101			
Library			
BA_Room_Laboratory_101_HQ_1			
Description			
Lab	Fume Hood	None	Central
Symbol			
			
Remarks:			
Substitutions		Set of Values	
Color		User can set the fume hood color. Default value: #FFF2F2F2	
Grill Visibility		0 = Grill is not visible 1 = Grill is visible (Default value)	
ODP Position		0 = Left 1 = Right (Default value)	

3.1.31. STA_3D_Lab_Fume Hood_None_Central_002_101

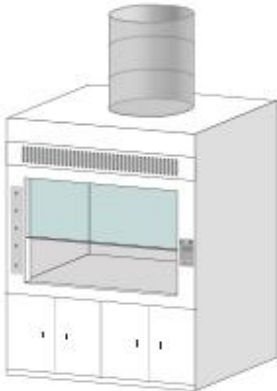
Symbol Name			
STA_3D_Lab_Fume Hood_None_Central_002_101			
Library			
BA_Room_Laboratory_101_HQ_1			
Description			
Lab	Fume Hood	None	Central
Symbol			
			
Remarks:			
Substitutions		Set of Values	
Color		User can set the fume hood color. Default value: #FFF2F2F2	
Grill Visibility		0 = Grill is not visible 1 = Grill is visible (Default value)	
ODP Position		0 = Left 1 = Right (Default value)	

3.1.32. STA_3D_Lab_Fume Hood_Dual Entry_Central_001_101

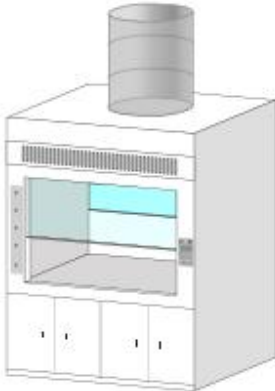
Symbol Name			
STA_3D_Lab_Fume Hood_Dual Entry_Central_001_101			
Library			
BA_Room_Laboratory_101_HQ_1			
Description			
Lab	Fume Hood	Dual Entry	Central
Symbol			
			
Remarks:			
Substitutions		Set of Values	
Color		User can set the fume hood color. Default value: #FFF2F2F2	
Grill Visibility		0 = Grill is not visible 1 = Grill is visible (Default value)	
ODP Position		0 = Left 1 = Right (Default value)	

3.1.33. STA_3D_Lab_Fume Hood_Walk In_Central_001_101

Symbol Name			
STA_3D_Lab_Fume Hood_Walk In_Central_001_101			
Library			
BA_Room_Laboratory_101_HQ_1			
Description			
Lab	Fume Hood	Walk In	Central
Symbol			
			
Remarks:			
Substitutions		Set of Values	
Color		User can set the fume hood color. Default value: #FFF2F2F2	
Grill Visibility		0 = Grill is not visible 1 = Grill is visible (Default value)	
ODP Position		0 = Left 1 = Right (Default value)	

3.1.34. STA_3D_Lab_Fume Hood_Multi Walk In_Central_001_101

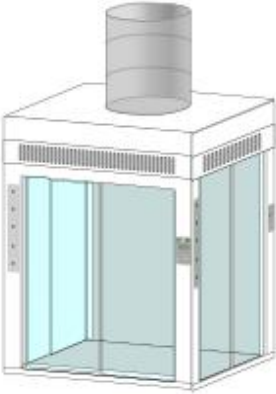
Symbol Name			
STA_3D_Lab_Fume Hood_Multi Walk In_Central_001_101			
Library			
BA_Room_Laboratory_101_HQ_1			
Description			
Lab	Fume Hood	Multi Walk In	Central
Symbol			
			
Remarks:			
Substitutions		Set of Values	
Color		User can set the fume hood color. Default value: #FFF2F2F2	
Grill Visibility		0 = Grill is not visible 1 = Grill is visible (Default value)	
ODP Position		0 = Left 1 = Right (Default value)	

3.1.35. STA_3D_Lab_Snorkel Hood_Central_001_101

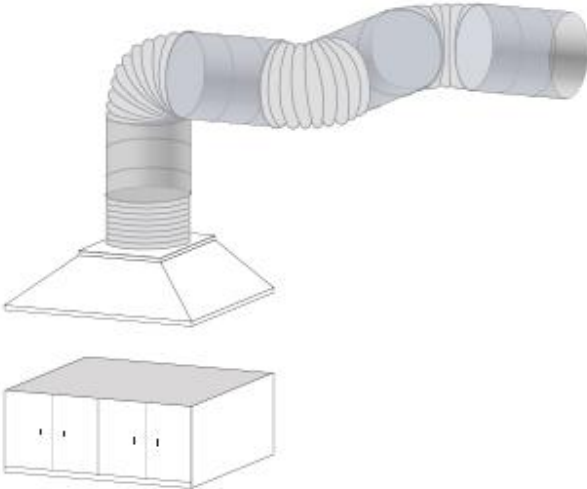
Symbol Name			
STA_3D_Lab_Snorkel Hood_Central_001_101			
Library			
BA_Room_Laboratory_101_HQ_1			
Description			
Lab	Snorkel Hood	Central	
Symbol			
			
Remarks:			
Substitutions		Set of Values	
Color		User can set the canopy and workbench color. Default value: #FFF2F2F2	

3.2. Sample graphics

These sample graphic pages could be used as a starting point for creation of a User specific dashboards.

Example:

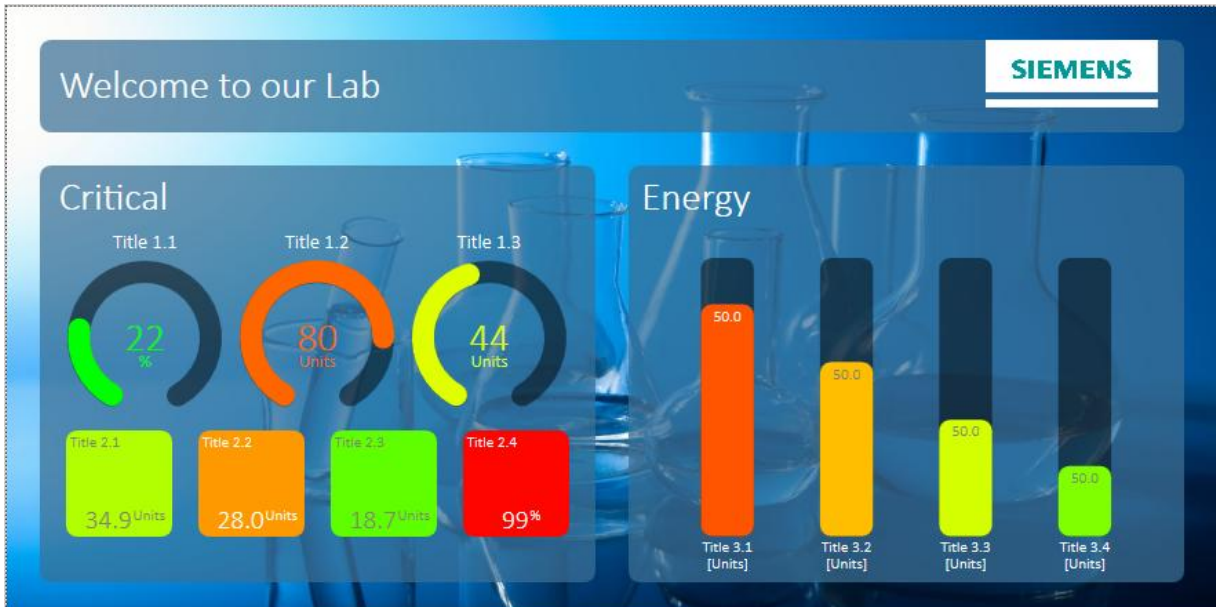

3.2.1. SampleGraphic_LifeScience_Dashboard_001_101

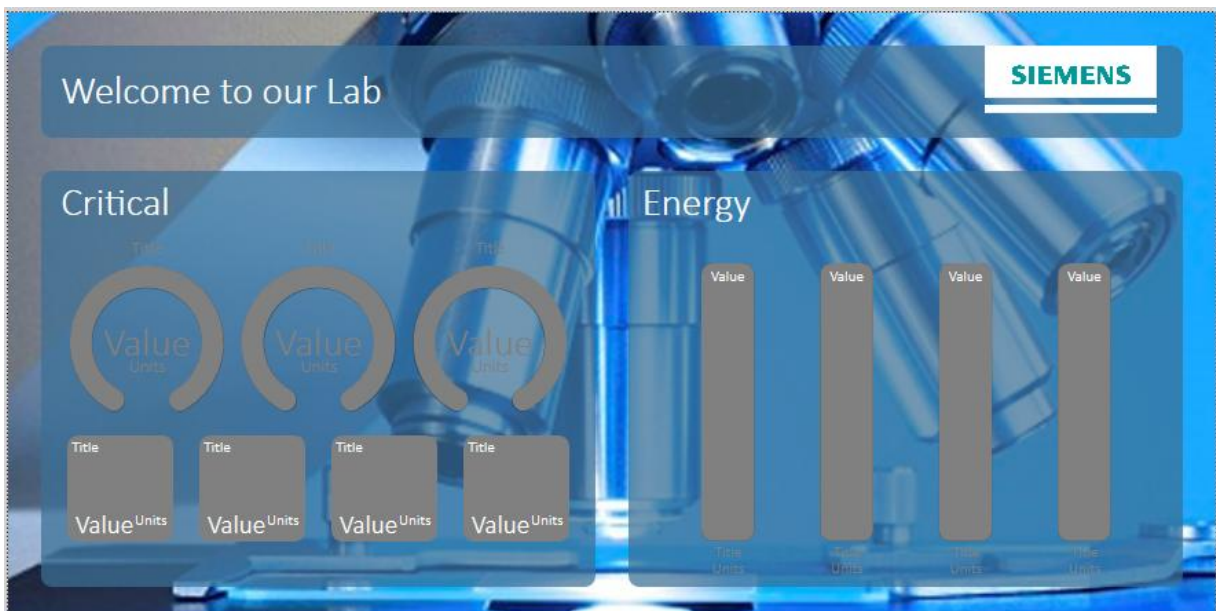

3.2.2. SampleGraphic_LifeScience_Dashboard_002_101

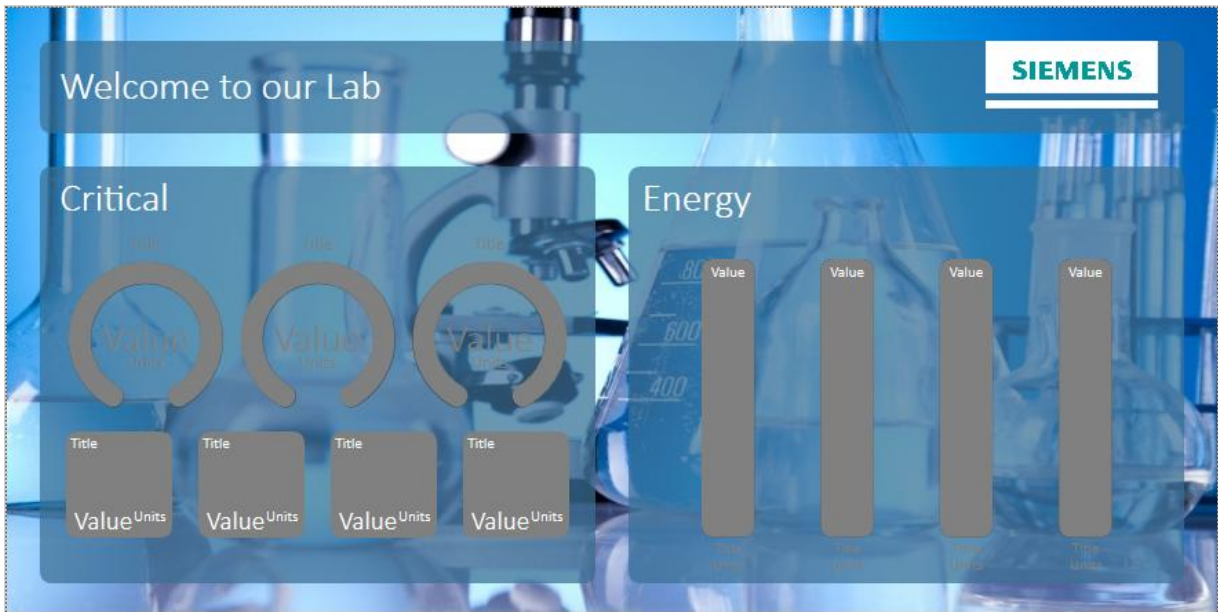

3.2.3. SampleGraphic_LifeScience_Dashboard_002_101

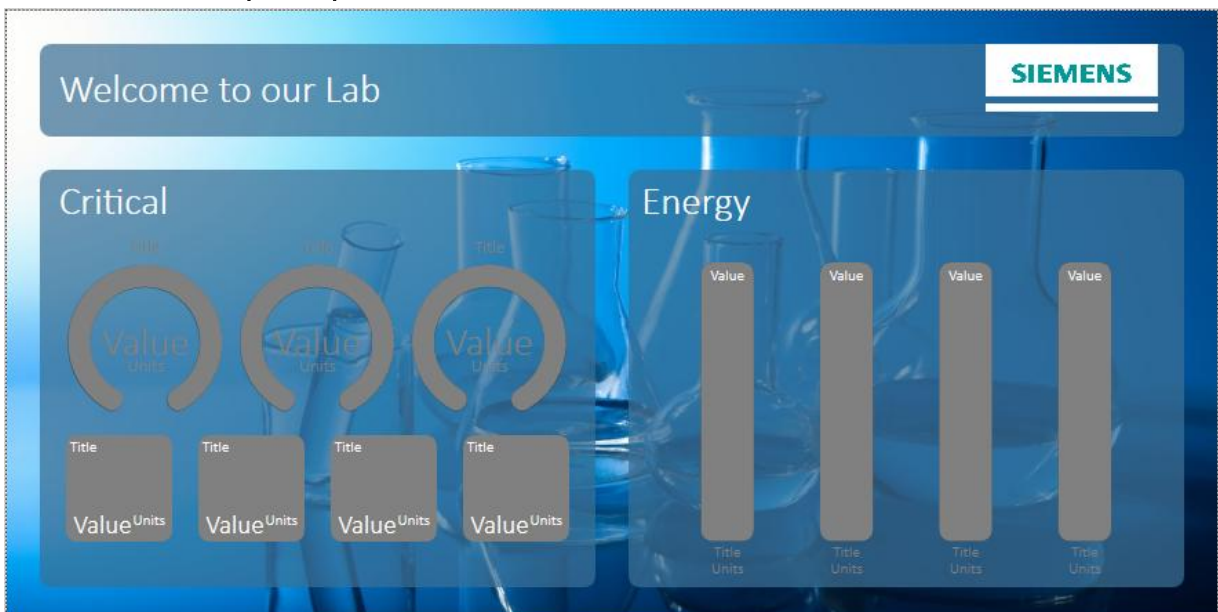

3.3. Icons

List of special icons created for the purpose of the Life Science library

Name	Icon
Op_Fct_FumeHood_Sash_001_101	 A blue square icon containing a white graphic of a fume hood sash with a diagonal line across it.